

Flachbodenglas

Korkstopfen

Korkdeckel

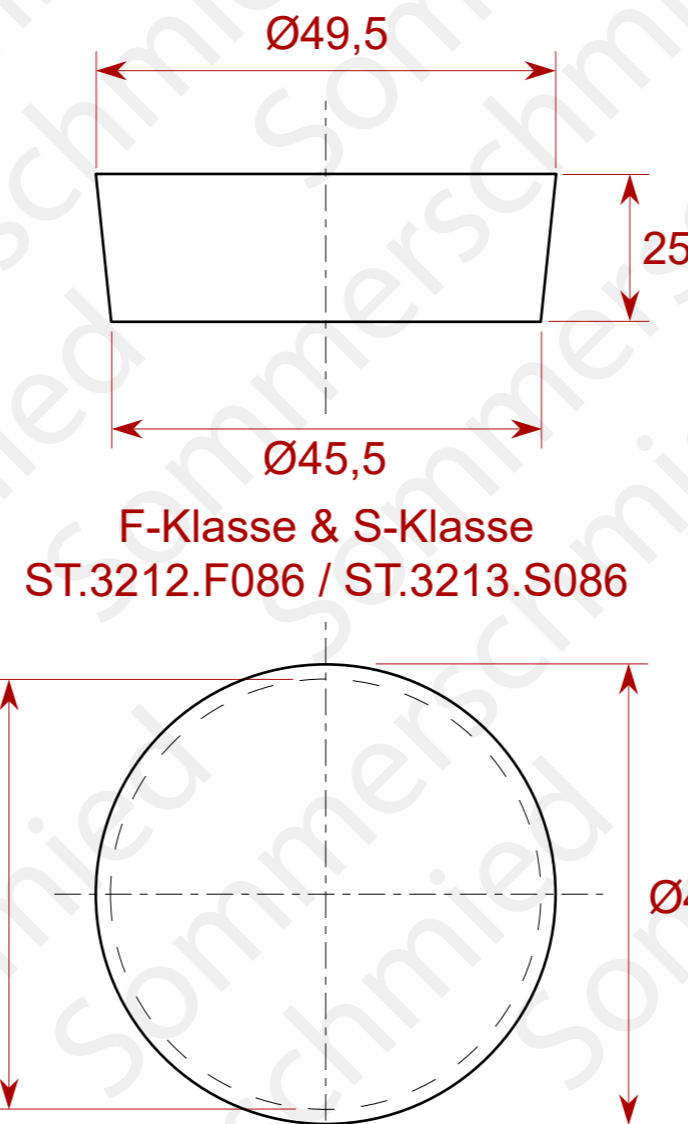
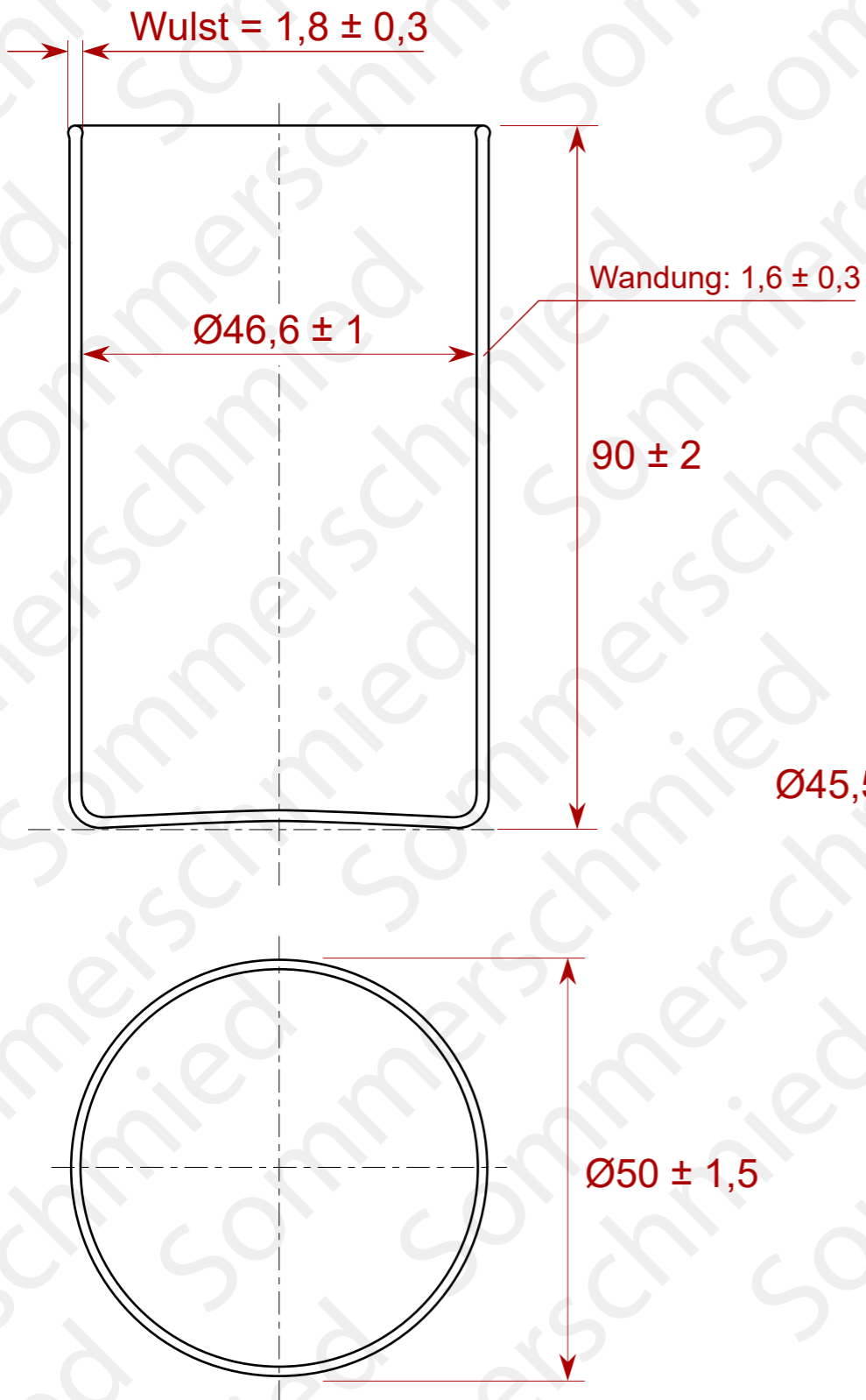

F-Klasse & S-Klasse
ST.3212.F086 / ST.3213.S086

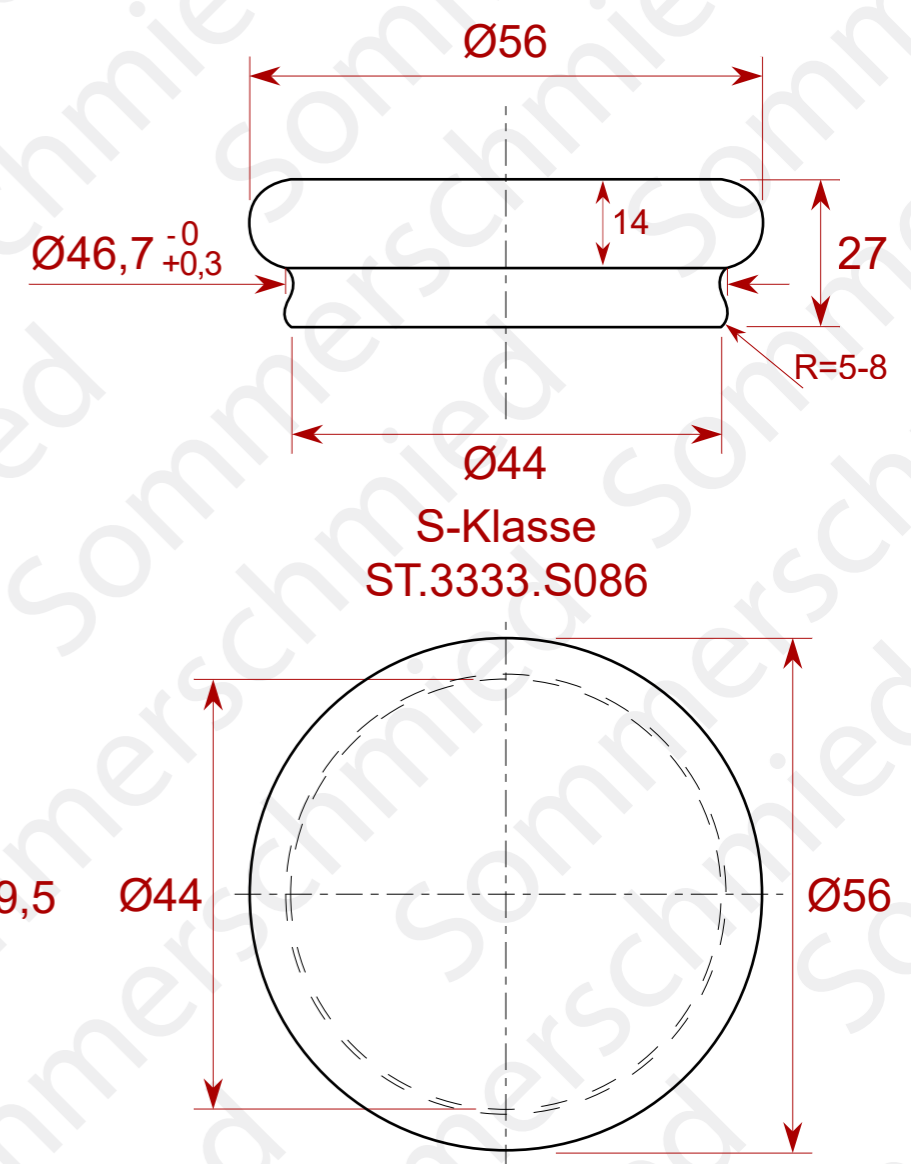

S-Klasse
ST.3333.S086

Volumen randvoll: 150ml

 Sommerschmied GmbH Labor- & Verpackungsglas	Flachbodenglas $90 \pm 2 \text{ mm} \times \text{Ø}50 \pm 1,5 \text{ mm}$ Wdg.: $1,6 \pm 0,3 \text{ mm}$			
	Sommerschmied GmbH Labor- & Verpackungsglas Oderstraße 60 D- 24539 Neumuenster		Artikelnummer 03.7511.7057 ST.3213.S086, ST.3333.S086	
	Datum	Name	Farbton	transparent
Bearb.	30.10.2015	M. Koziwicz	Material 1	Boro 3.3
Geprüft	30.05.2016	K. Ediger	Material 2	Kork
Änderung	27.08.2016	Index: 13		